

PWD50 SURGE MODULE REPLACEMENT INSTRUCTIONS

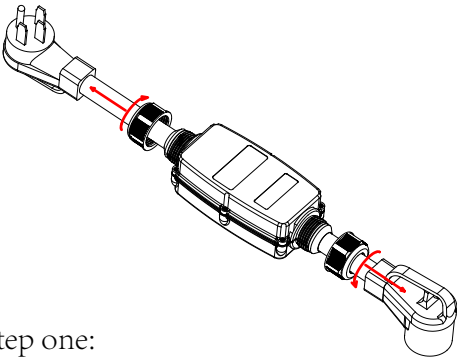

Step one:
Loosen and unscrew the top and bottom cable gland connectors.

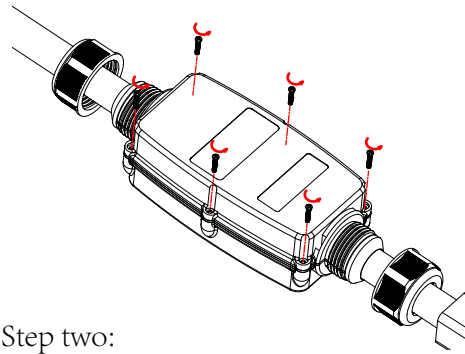

Step two:
Unscrew the 8 Phillips screws (M3*16) on the back side of the unit.

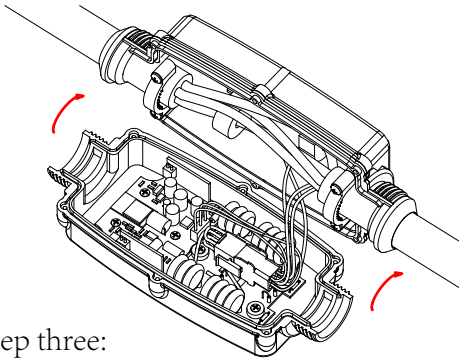

Step three:
Carefully separate the top and bottom halves of the Power Watchdog Unit.

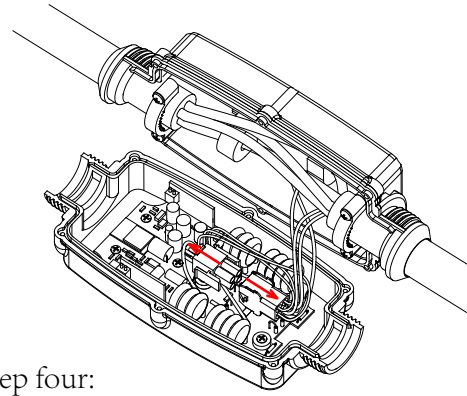

Step four:
Unclip the connections. Take note of where these connections come from.

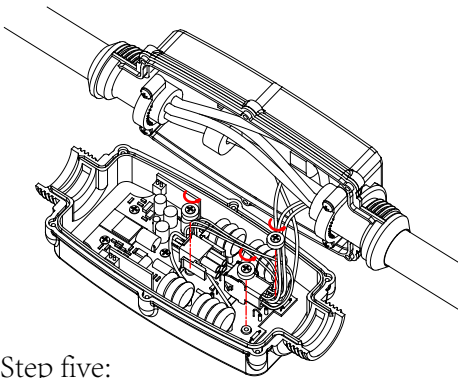

Step five:
Unscrew the 3 phillips screws.
Holding down the surge board.

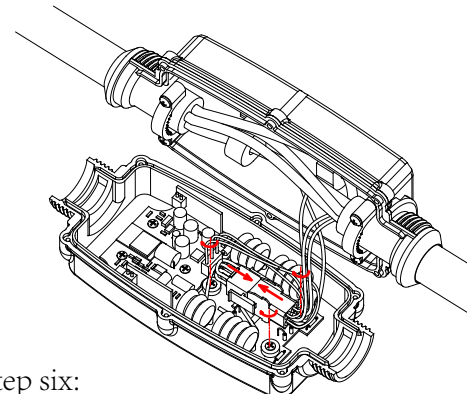

Step six:
Place in the new surge module, rescrew the 3 screws, clip together the wire connections.

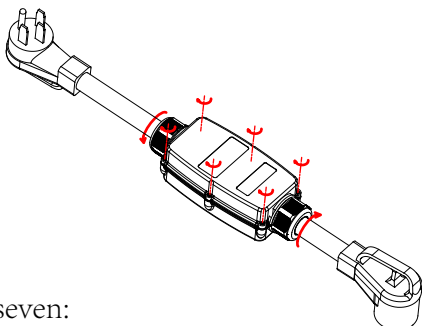

Step seven:
Place top and bottom halves together, rescrew all the screws, tighten down the cable gland connectors.
*Do not overtighten the screws.