

PWD50-EPO SURGE MODULE REPLACEMENT INSTRUCTIONS

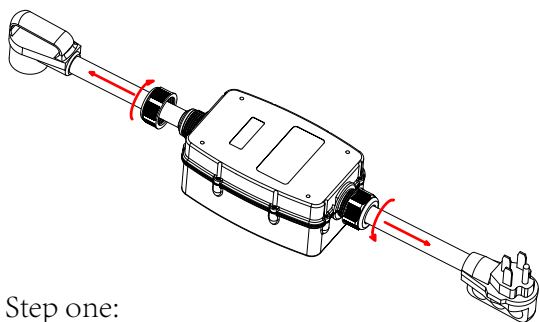

Step one:
Loosen and unscrew the top and bottom cable gland connectors.

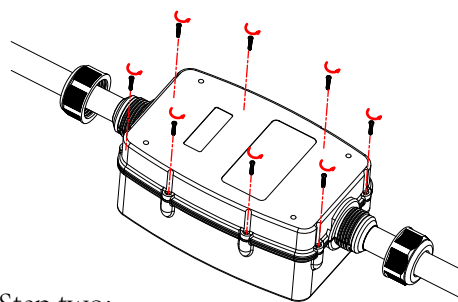

Step two:
Unscrew the 8 Phillips screws (M3*16) on the back side of the unit.

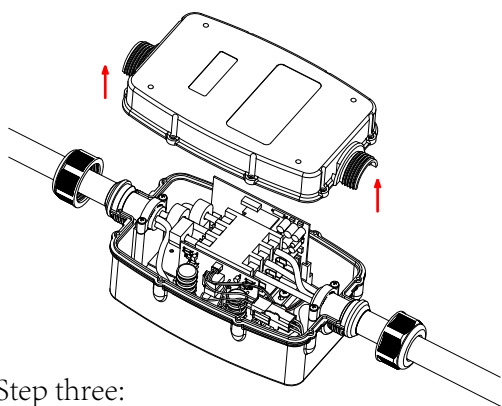

Step three:
Carefully separate the top and bottom halves of the Power Watchdog Unit.

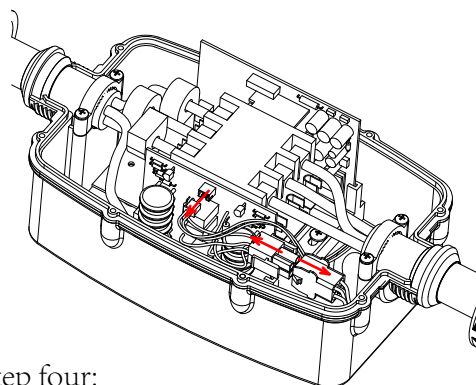

Step four:
Unclip the connections. Take note of where these connections come from.

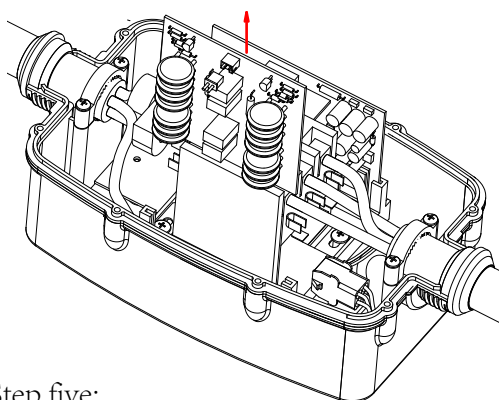

Step five:
Carefully slide out the used up surge module.

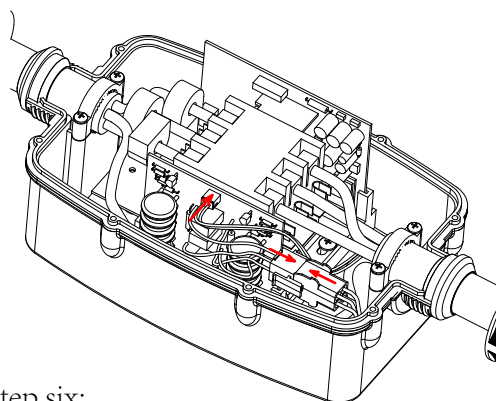

Step six:
Slide in the new surge module into the slots inside the Power Watchdog unit. clip together the connections.
*Note-you may use the white connector only, or you may use the red and white connectors. Just match the color and size of your connectors.

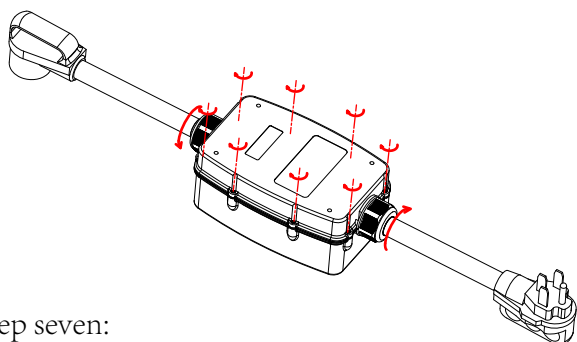

Step seven:
Place top and bottom halves together, rescrew all the screws, tighten down the cable gland connectors.
*Do not overtighten the screws.